

6FM180SHX 12V 180Ah(10hr)

The rechargeable batteries are lead-lead dioxide systems. The dilute sulfuric acid electrolyte is absorbed by separators and plates and thus immobilized. Should the battery be accidentally overcharged producing hydrogen and oxygen, special one-way valves allow the gases to escape thus avoiding excessive pressure build-up. Otherwise, the battery is completely sealed and is, therefore, maintenance-free, leak proof and usable in any position.

Battery Construction

Component	Positive plate	Negative plate	Container	Cover	Safety valve	Terminal	Separator	Electrolyte
Raw material	Lead dioxide	Lead	ABS	ABS	Rubber	Copper	Fiberglass	Sulfuric acid

General Features

- Absorbent Glass Mat (AGM) technology for efficient gas recombination of up to 99% and freedom from electrolyte maintenance or water adding.
- Not restricted for air transport-complies with IATA/ICAO Special Provision A67.
- UL-recognized component.
- Can be mounted in any orientation.
- Computer designed lead, calcium tin alloy grid for high power density.
- Long service life, float or cyclic applications.
- Maintenance-free operation.
- Low self discharge.

Dimensions and Weight

Length(mm / inch)	522 / 20.55
Width(mm / inch)	238 / 9.37
Height(mm / inch)	218 / 8.58
Total Height(mm / inch)	223 / 8.78
Approx. Weight(Kg / lbs)	62 / 136.7

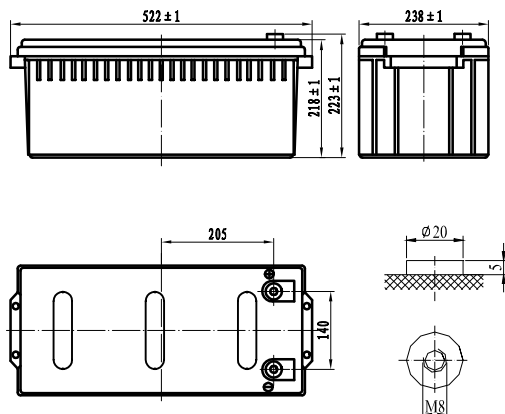

Performance Characteristics

Nominal Voltage	12V
Number of cell	6
Design Life	12 years
Nominal Capacity 77°F(25°C)	
10 hour rate (18.8A, 10.5V)	180Ah
5 hour rate (35.7A, 10.5V)	178.5Ah
1 hour rate (137A, 9.6V)	137Ah
Internal Resistance	
Fully Charged battery 77°F(25°C)	3.5mOhms
Self-Discharge	
3% of capacity declined per month at 20°C(average)	
Operating Temperature Range	
Discharge	-20~60°C
Charge	-10~60°C
Storage	-20~60°C
Max. Discharge Current 77°F(25°C)	900A(5s)
Short Circuit Current	3200A
Charge Methods: Constant Voltage Charge 77°F(25°C)	
Cycle use	14.4-14.7V
Maximum charging current	57.6A
Temperature compensation	-20mV/°C
Standby use	13.6-13.8V
Temperature compensation	-30mV/°C

Discharge Constant Current (Amperes at 77°F25°C)

End Point Volts/Cell	10min	15min	30min	1h	3h	5h	10h	20h
1.60V	381	309	210	137	61.9	40.5	20.5	10.00
1.65V	358	290	197	129	59.0	38.9	19.9	9.87
1.70V	338	276	188	124	56.7	37.9	19.5	9.67
1.75V	312	253	172	114	53.3	35.7	18.8	9.60
1.80V	287	234	160	107	50.1	33.7	18.0	9.41

Discharge Constant Power (Watts at 77°F25°C)

End Point Volts/Cell	10min	15min	30min	45min	1h	2h	3h	5h
1.60V	665	550	377	293	251	153	116	76.1
1.65V	634	524	360	280	241	147	112	74.2
1.70V	608	507	349	273	235	143	109	73.5
1.75V	569	471	323	254	219	136	104	70.2
1.80V	532	443	306	241	208	129	100	67.3

(Note)The above characteristics data are average values obtained within three charge/discharge cycles not the minimum values.

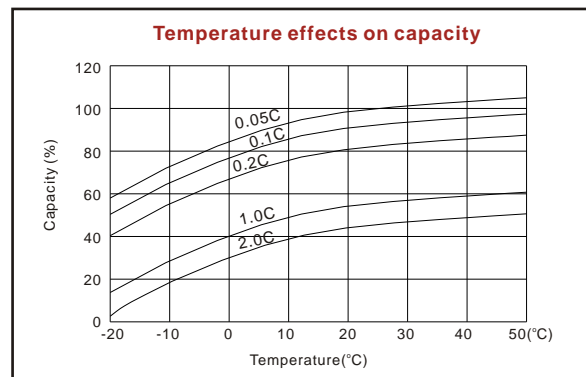
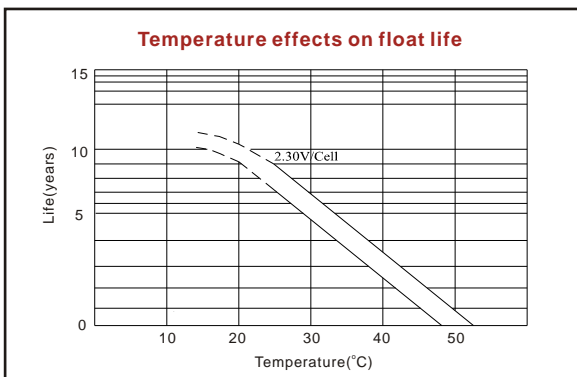
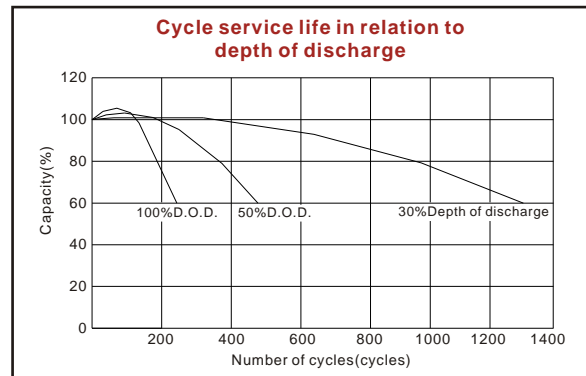
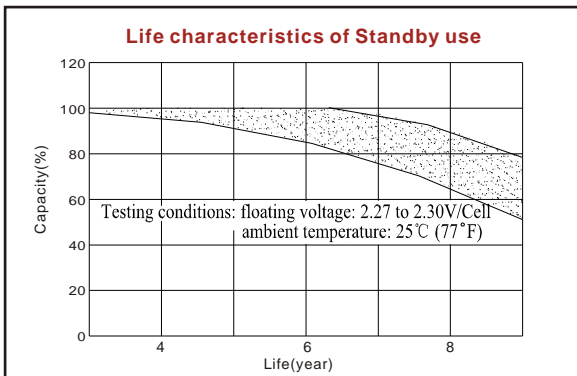
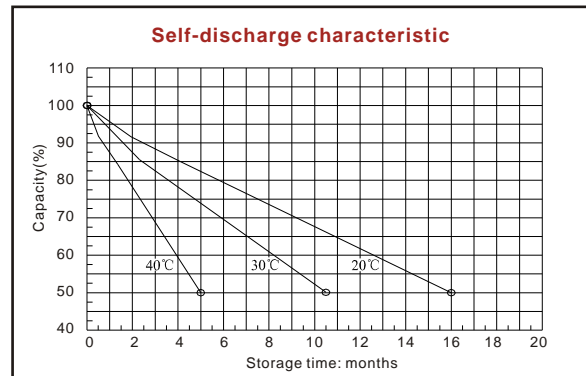
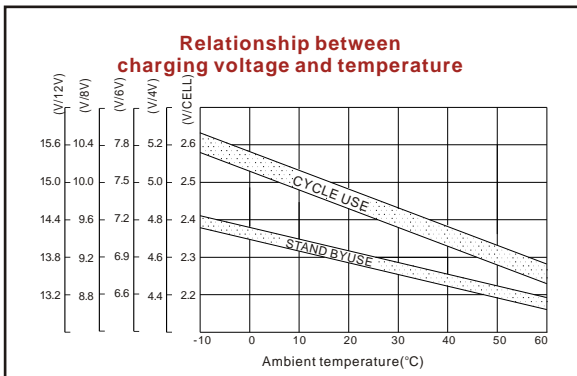
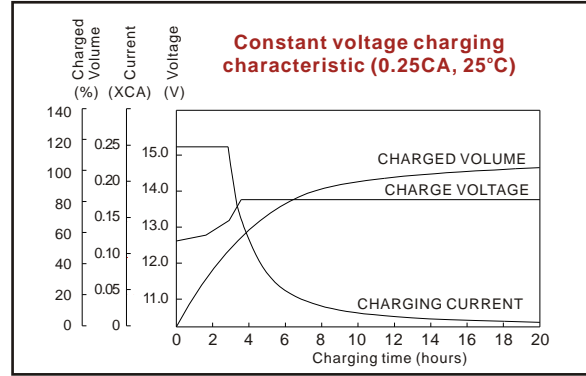
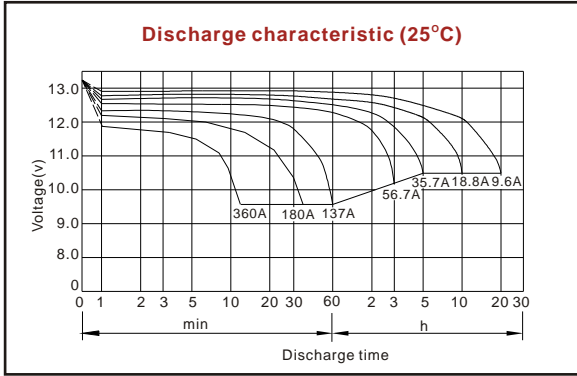

ISO9001:2000

MH25860

G4M19906-9202-E-16

www.vision-batt.com

Shenzhen Center Power Tech. Co., Ltd.
 Center Power Industrial Park, Tongfu Industrial District Dapeng Town, 518120 Shenzhen, China
 Tel: (+86-755) 8431 8088 Fax: (+86-755) 8431 8038 E-mail: sales@vision-batt.com